

Voltage Controlled Clock OSC.

Surface Mount

ADVCXOG Series (G4, G6)

ADVCXOG4

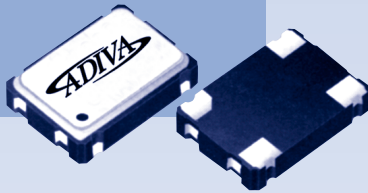

ADVCXOG6

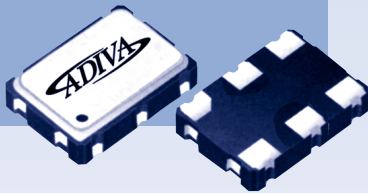

FEATURES

- Seam welding
- Superior quality
- Low power consumption
- Custom requirement available
- Application: Set top box, ADSL modem.

ADVCXOG4 (unit: mm)

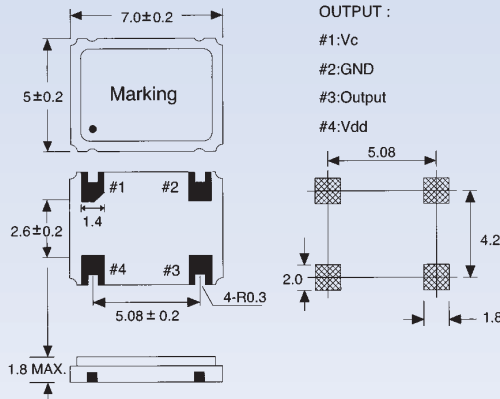

ADVCXOG6 (unit: mm)

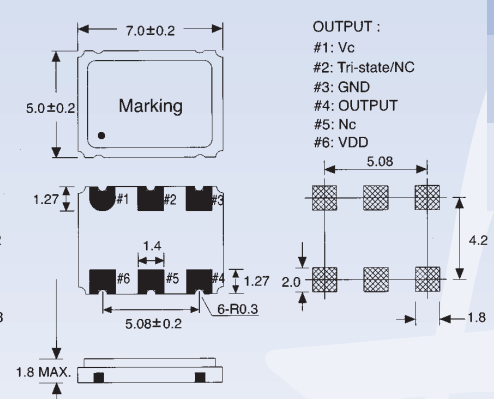

SOLDERING REFLOW PROFILE

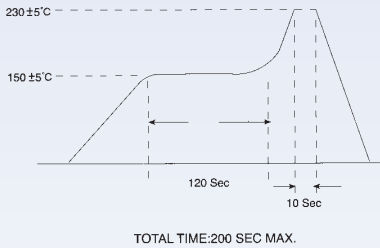

FREQUENCY/MODULATION VOLTAGE CHARACTERISTICS

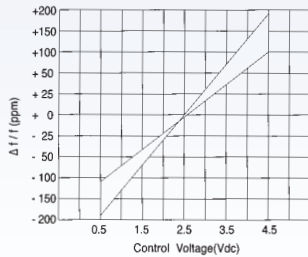

TEST CIRCUIT

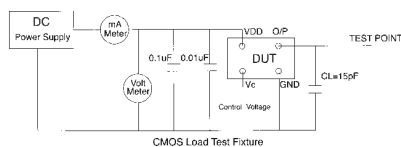

CMOS Load Test Fixture

*A 0.1µF tantalum capacitor and 0.01µF chip ceramic capacitor should be connected on the VDD terminal is recommended for the application.

REEL PACKING (unit: mm)

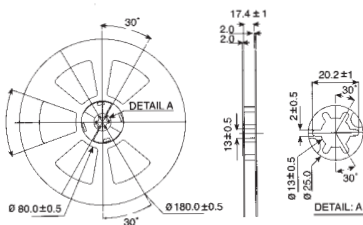

Tape reel 1000pcs/reel

OUTPUT WAVEFORM FOR CMOS

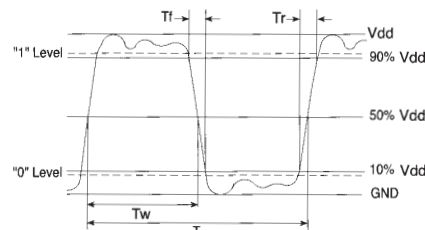

Symmetry=(Tw/T)*100% measured at 50% Vdd

TAPE SPECIFICATIONS

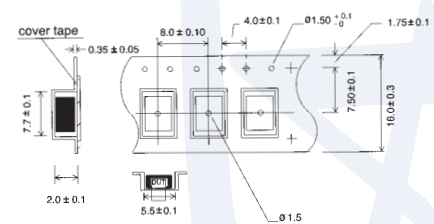

SEE PAGE 48 FOR PART NUMBERING GUIDE

Voltage Controlled Clock OSC.

Surface Mount & Thru Hole

ADVCXO Series



Package Type	ADVCXOG4	pg49	ADVCXOI	pg50
	ADVCXOG6	pg49	ADVCXOH	pg52
Frequency Stability	±100 ppm	A	±25 ppm	D
	±50 ppm	B	Custom	E
	±30 ppm	C		
Duty Cycle	45/55%	5	40/60%	6
Deviation	±100 ppm min	A	±50 ppm min	C
	±75 ppm min	B	±200 ppm min	D
Linearity	20%	A	10%	C
	15%	B	None	Blank
Output	TTL	A	CMOS Compatible	C
	CMOS	B		

EXAMPLE

