

MC1489
MC1489A

QUAD LINE RECEIVERS

The MC1489 monolithic quad line receivers are designed to interface data terminal equipment with data communications equipment in conformance with the specifications of EIA Standard No. RS-232C.

- Input Resistance — 3.0 k to 7.0 kilohms
- Input Signal Range — ± 30 Volts
- Input Threshold Hysteresis Built In
- Response Control
 - a) Logic Threshold Shifting
 - b) Input Noise Filtering

QUAD MDTL
LINE RECEIVERS
RS-232C

SILICON MONOLITHIC
INTEGRATED CIRCUIT

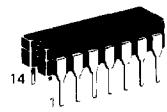

L SUFFIX
 CERAMIC PACKAGE
 CASE 632



P SUFFIX
 PLASTIC PACKAGE
 CASE 646

D SUFFIX
 PLASTIC PACKAGE
 CASE 751A
 (SO-14)

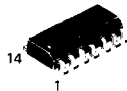

TYPICAL APPLICATION

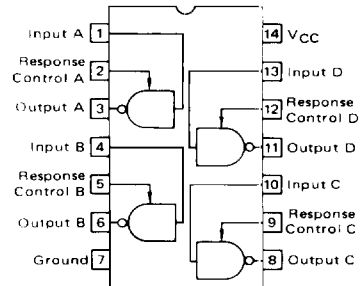
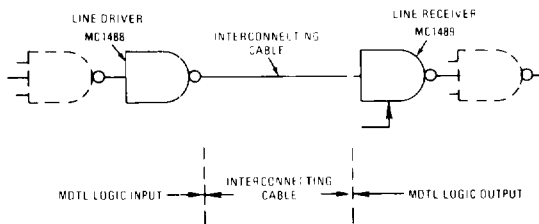

EQUIVALENT CIRCUIT SCHEMATIC (1/4 OF CIRCUIT SHOWN)

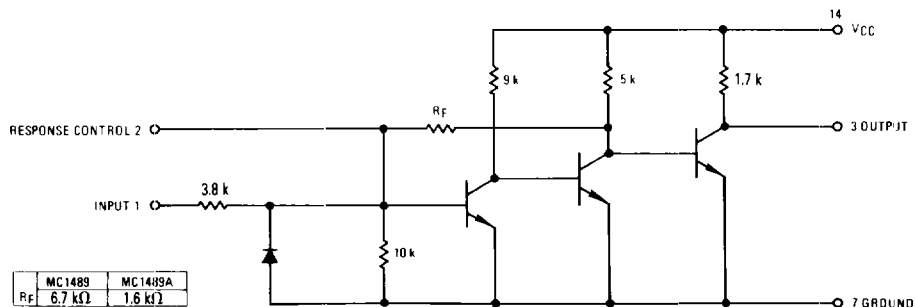

MDTL and MTTL are trademarks of Motorola Inc.

MAXIMUM RATINGS ($T_A = +25^\circ\text{C}$ unless otherwise noted)

Rating	Symbol	Value	Unit
Power Supply Voltage	V_{CC}	10	Vdc
Input Voltage Range	V_{IR}	+30	Vdc
Output Load Current	I_L	20	mA
Power Dissipation (Package Limitation, Ceramic and Plastic Dual In-Line Package) Derate above $T_A = +25^\circ\text{C}$	P_D $1/\theta_{JA}$	1000 6.7	mW mW/°C
Operating Ambient Temperature Range	T_A	0 to +75	°C
Storage Temperature Range	T_{stg}	65 to +175	°C

ELECTRICAL CHARACTERISTICS (Response control pin is open) ($V_{CC} = +5.0\text{ Vdc} \pm 10\%$, $T_A = 0\text{ to }+75^\circ\text{C}$ unless otherwise noted)

Characteristics	Symbol	Min	Typ	Max	Unit
Positive Input Current ($V_{IH} = +25\text{ Vdc}$) ($V_{IH} = +3.0\text{ Vdc}$)	I_{IH}	3.6 0.43	—	8.3 —	mA
Negative Input Current ($V_{IL} = -25\text{ Vdc}$) ($V_{IL} = -3.0\text{ Vdc}$)	I_{IL}	-3.6 -0.43	—	-8.3 —	mA
Input Turn-On Threshold Voltage ($T_A = +25^\circ\text{C}$, $V_{OL} \leq 0.45\text{ V}$)	V_{IH}	1.0 1.75	— 1.95	1.5 2.25	Vdc
Input Turn-Off Threshold Voltage ($T_A = +25^\circ\text{C}$, $V_{OH} \geq 2.5\text{ V}$, $I_L = -0.5\text{ mA}$)	V_{IL}	0.75 0.75	— 0.8	1.25 1.25	Vdc
Output Voltage High ($V_{IH} = 0.75\text{ V}$, $I_L = -0.5\text{ mA}$) (Input Open Circuit, $I_L = -0.5\text{ mA}$)	V_{OH}	2.5 2.5	4.0 4.0	5.0 5.0	Vdc
Output Voltage Low ($V_{IL} = 3.0\text{ V}$, $I_L = 10\text{ mA}$)	V_{OL}	—	0.2	0.45	Vdc
Output Short-Circuit Current	I_{OS}	—	-3.0	-4.0	mA
Power Supply Current: (All Gates "on," $I_{out} = 0\text{ mA}$, $V_{IH} = +5.0\text{ Vdc}$)	I_{CC}	—	16	26	mA
Power Consumption ($V_{IH} = +5.0\text{ Vdc}$)	P_C	—	80	130	mW

SWITCHING CHARACTERISTICS ($V_{CC} = 5.0\text{ Vdc} \pm 1\%$, $T_A = +25^\circ\text{C}$, See Figure 1.)

Propagation Delay Time	($R_L = 3.9\text{ k}\Omega$)	t_{PLH}	—	25	85	ns
Rise Time	($R_L = 3.9\text{ k}\Omega$)	t_{TLH}	—	120	175	ns
Propagation Delay Time	($R_L = 390\text{ k}\Omega$)	t_{PHL}	—	25	50	ns
Fall Time	($R_L = 390\text{ k}\Omega$)	t_{THL}	—	10	20	ns

TEST CIRCUITS

FIGURE 1 — SWITCHING RESPONSE

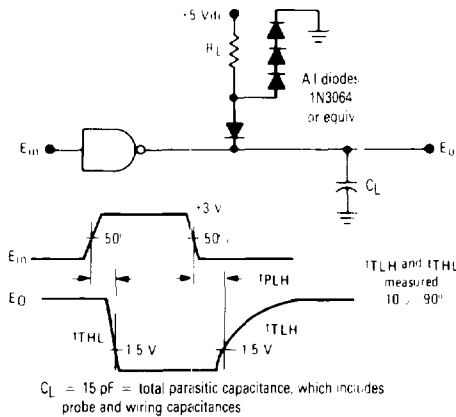
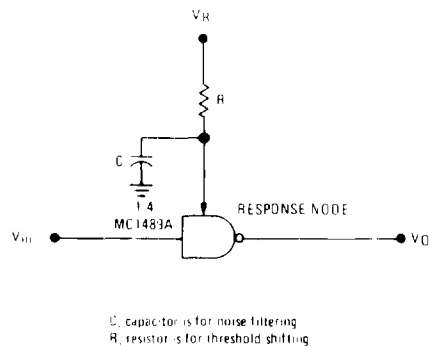

FIGURE 2 — RESPONSE CONTROL NODE



TYPICAL CHARACTERISTICS

($V_{CC} = 5.0 \text{ Vdc}$, $T_A = +25^\circ\text{C}$ unless otherwise noted)

FIGURE 3 — INPUT CURRENT

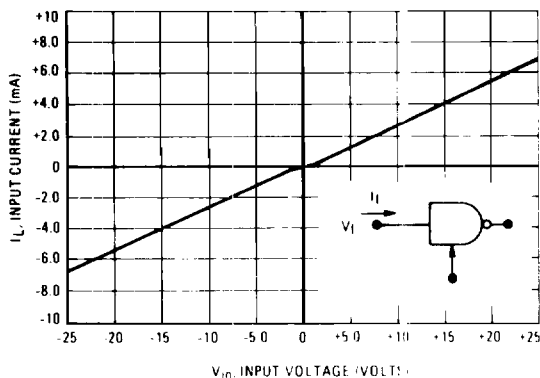

FIGURE 4 — MC1489 INPUT THRESHOLD VOLTAGE ADJUSTMENT

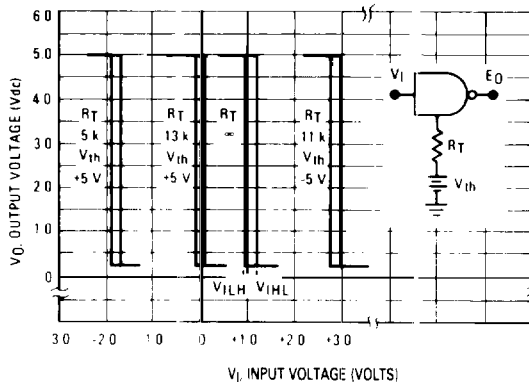

FIGURE 5 — MC1489A INPUT THRESHOLD VOLTAGE ADJUSTMENT

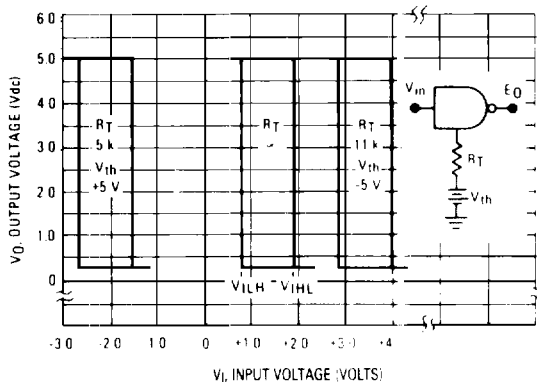

FIGURE 6 — INPUT THRESHOLD VOLTAGE versus TEMPERATURE

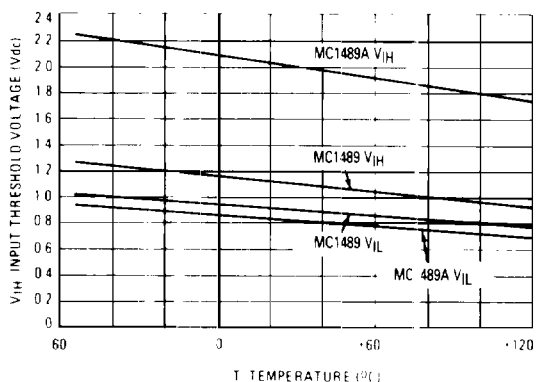
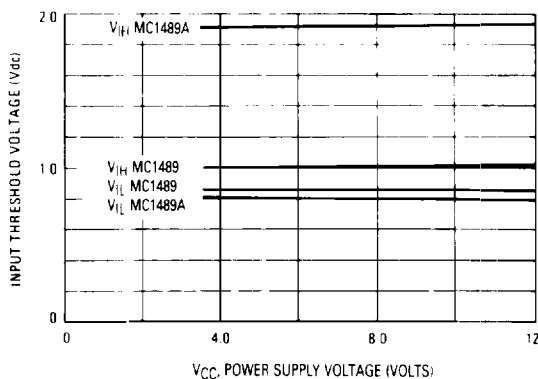

FIGURE 7 — INPUT THRESHOLD versus POWER-SUPPLY VOLTAGE



APPLICATIONS INFORMATION

General Information

The Electronic Industries Association (EIA) has released the RS-232C specification detailing the requirements for the interface between data processing equipment and data communications equipment. This standard specifies not only the number and type of interface leads, but also the voltage levels to be used. The MC1488 quad driver and its companion circuit, the MC1489 quad receiver, provide a complete interface system between DTL or TTL logic levels and the RS-232C defined levels. The RS-232C requirements as applied to receivers are discussed herein.

The required input impedance is defined as between 3000 ohms and 7000 ohms for input voltages between 3.0 and 25 volts in magnitude; and any voltage on the receiver input in an open circuit condition must be less than 2.0 volts in magnitude. The MC1489 circuits meet these requirements with a maximum open circuit voltage of one V_{BE} .

The receiver shall detect a voltage between -3.0 and -25 volts as a Logic "1" and inputs between $+3.0$ and $+25$ volts as a Logic "0." On some interchange leads, an open circuit of power "OFF" condition (300 ohms or more to ground) shall be decoded as an "OFF" condition or Logic "1." For this reason, the input hysteresis thresholds of the MC1489 circuits are all above ground. Thus an open or grounded input will cause the same output as a negative or Logic "1" input.

Device Characteristics

The MC1489 interface receivers have internal feedback from the second stage to the input stage providing input

hysteresis for noise rejection. The MC1489 input has typical turn-on voltage of 1.25 volts and turn-off of 1.0 volt for a typical hysteresis of 250 mV. The MC1489A has typical turn-on of 1.95 volts and turn-off of 0.8 volt for typically 1.15 volts of hysteresis.

Each receiver section has an external response control node in addition to the input and output pins, thereby allowing the designer to vary the input threshold voltage levels. A resistor can be connected between this node and an external power-supply. Figures 2, 4 and 5 illustrate the input threshold voltage shift possible through this technique.

This response node can also be used for the filtering of high-frequency, high-energy noise pulses. Figures 8 and 9 show typical noise-pulse rejection for external capacitors of various sizes.

These two operations on the response node can be combined or used individually for many combinations of interfacing applications. The MC1489 circuits are particularly useful for interfacing between MOS circuits and MDTL/MTTL logic systems. In this application, the input threshold voltages are adjusted (with the appropriate supply and resistor values) to fall in the center of the MOS voltage logic levels. (See Figure 10)

The response node may also be used as the receiver input as long as the designer realizes that he may not drive this node with a low impedance source to a voltage greater than one diode above ground or less than one diode below ground. This feature is demonstrated in Figure 11 where two receivers are slaved to the same line that must still meet the RS-232C impedance requirement.

FIGURE 8 — TYPICAL TURN-ON THRESHOLD versus CAPACITANCE FROM RESPONSE CONTROL PIN TO GND

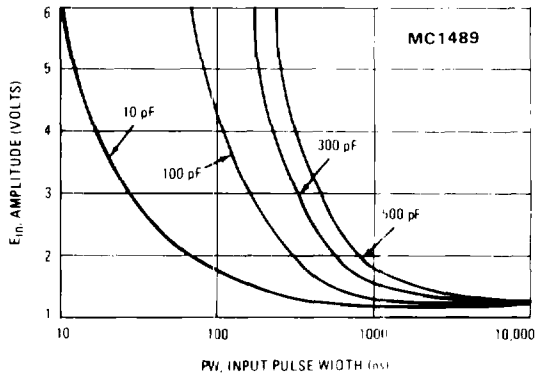
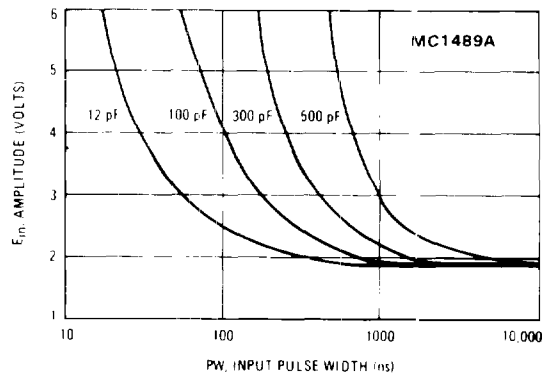

FIGURE 9 — TYPICAL TURN-ON THRESHOLD versus CAPACITANCE FROM RESPONSE CONTROL PIN TO GND



APPLICATIONS INFORMATION (continued)

FIGURE 10 — TYPICAL TRANSLATOR APPLICATION —
MOS TO DTL OR TTL

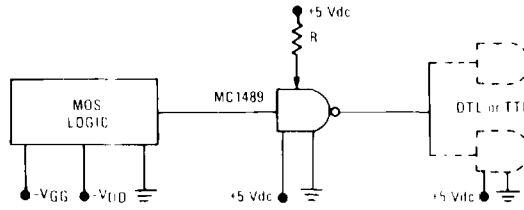
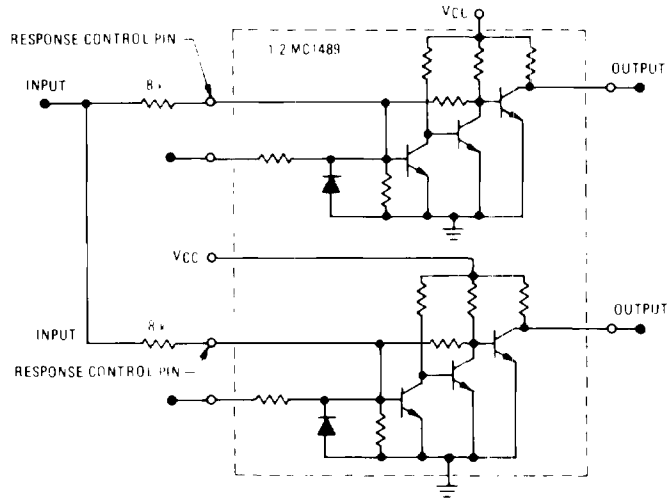

FIGURE 11 — TYPICAL PARALLELING OF TWO MC1489,A RECEIVERS TO MEET RS-232C



APPLICATIONS INFORMATION (continued)

FIGURE 11 — TYPICAL PARALLELING OF TWO MC1489,A RECEIVERS TO MEET RS-232C

